





Grayhill, Inc.

62S11-L4-025SH

Número da peça:	62S11-L4-025SH
Fabricante / Marca:	Grayhill, Inc.
Descrição do Produto	ROTARY ENCODER OPTICAL 32PPR
Folhas de dados:	 62S11-L4-025SH.pdf
Status de RoHs	 Sem chumbo / RoHS complacente
Condição de estoque	2264 pcs stock
Navio De	Hong Kong
Caminho de embarque	DHL/Fedex/TNT/UPS/EMS



[SOLICITAÇÃO DE COTAÇÃO](#)

Imagem pode ser representação. Veja as especificações para detalhes do produto.



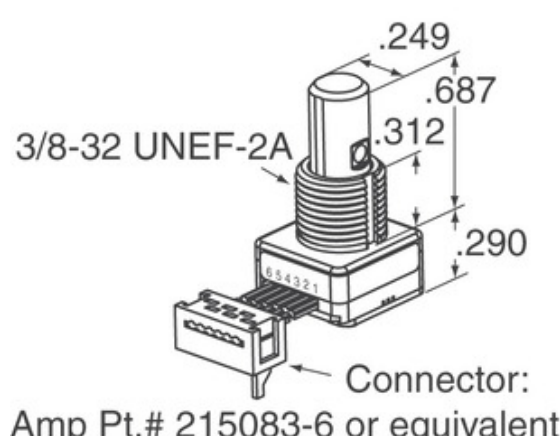

Especificações do 62S11-L4-025SH

NÚMERO DA PEÇA	62S11-L4-025SH
FABRICANTE	Grayhill, Inc.
DESCRIÇÃO	ROTARY ENCODER OPTICAL 32PPR
STATUS SEM CHUMBO / STATUS ROHS	Sem chumbo / RoHS complacente
QUANTIDADE DISPONÍVEL	2264 pcs
FICHA DE DADOS	 62S11-L4-025SH.pdf
TENSÃO - FORNECIMENTO	5V
ESTILO DE ACABAMENTO	Cable Leads
SÉRIE	62S
VIDA DE ROTAÇÃO (CICLOS MIN)	1M
PULSOS POR REVOLUÇÃO	32
TIPO DE SAÍDA	Quadrature (Incremental)
OUTROS NOMES	62S11L4025SH
ORIENTAÇÃO	Vertical
TIPO DE MONTAGEM	Panel Mount
NÍVEL DE SENSIBILIDADE À UMIDADE (MSL)	1 (Unlimited)
STATUS SEM CHUMBO / STATUS DE ROHS	Lead free / RoHS Compliant
TIPO ENCODER	Optical
DETENTOR	Yes
CONSTRUÍDO EM MUDAR	Yes
TIPO DE ATUADOR	1/4" Dia Flatted End

Tags relacionadas

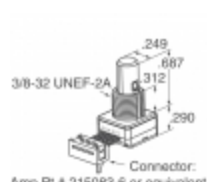
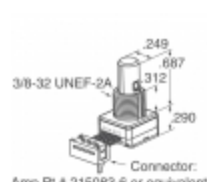
Grayhill, Inc. 62S11-L4-025SH	Distribuidor 62S11-L4-025SH	Fornecedor 62S11-L4-025SH
Preço 62S11-L4-025SH	Fotos de 62S11-L4-025SH	Imagem 62S11-L4-025SH
Folha de dados em PDF 62S11-L4-025SH	Folha de dados do download de 62S11-L4-025SH	Folha de dados 62S11-L4-025SH
Estoque 62S11-L4-025SH	Compre 62S11-L4-025SH	Compre Grayhill, Inc. 62S11-L4-025SH
Grayhill, Inc. 62S11-L4-025SH	Fornecedor Grayhill, Inc.	Distribuidor Grayhill, Inc.
Grayhill, Inc. 62S11-L4-025SH	Grayhill Inc. 62S11-L4-025SH	

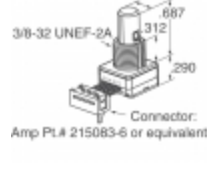
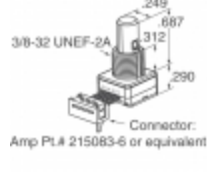
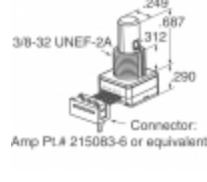
produtos relacionados

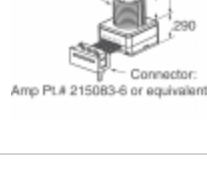
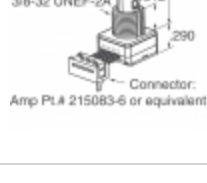
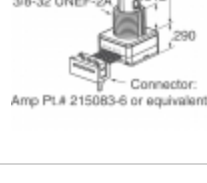
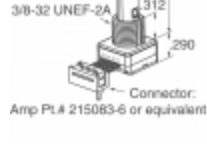
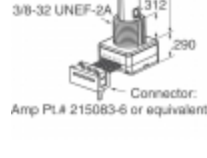
 <p>62S11-L0-PH Fabricantes: Grayhill, Inc. Descrição: ROTARY ENCODER OPTICAL 32PPR Em estoque: 2460 pcs</p> <p>RFQ</p>	 <p>62S11-L4-080C Fabricantes: Grayhill, Inc. Descrição: ROTARY ENCODER OPTICAL 32PPR Em estoque: 1843 pcs</p> <p>RFQ</p>
 <p>62S11-L4-050CH Fabricantes: Grayhill, Inc. Descrição: ROTARY ENCODER OPT 32PPR 4" CBL Em estoque: 2019 pcs</p> <p>RFQ</p>	 <p>62S11-L4-030S Fabricantes: Grayhill, Inc. Descrição: ROTARY ENCODER OPTICAL 32PPR Em estoque: 1829 pcs</p> <p>RFQ</p>
 <p>62S11-L4-020S Fabricantes: Grayhill, Inc. Descrição: ROTARY ENCODER OPT 32PPR 2" CBL Em estoque: 1879 pcs</p> <p>RFQ</p>	 <p>62S11-L0-PHV Fabricantes: Grayhill, Inc. Descrição: ROTARY ENCODER OPTICAL 32PPR Em estoque: 1991 pcs</p> <p>RFQ</p>
 <p>62S11-L4-050C Fabricantes: Grayhill, Inc. Descrição: ROTARY ENCODER OPT 32PPR 4" CBL Em estoque: 2211 pcs</p> <p>RFQ</p>	 <p>62S11-L4-040C Fabricantes: Grayhill, Inc. Descrição: ROTARY ENCODER OPTICAL 32PPR Em estoque: 2290 pcs</p> <p>RFQ</p>
 <p>62S11-L0-P Fabricantes: Grayhill, Inc. Descrição: ROTARY ENCODER OPTICAL 32PPR Em estoque: 2100 pcs</p> <p>RFQ</p>	 <p>62S11-L4-040CH Fabricantes: Grayhill, Inc. Descrição: ROTARY ENCODER OPTICAL 32PPR Em estoque: 1716 pcs</p> <p>RFQ</p>
 <p>62S11-L4-020C Fabricantes: Grayhill, Inc. Descrição: ROTARY ENCODER OPTICAL 32PPR Em estoque: 2162 pcs</p> <p>RFQ</p>	 <p>62S11-L0-060SH Fabricantes: Grayhill, Inc. Descrição: ROTARY ENCODER OPTICAL 32PPR Em estoque: 2073 pcs</p> <p>RFQ</p>

Copyright © 2020 Distribuidor confiável de componentes eletrônicos

O email: Info@infinity-electronic.com

Endereço: 17F, Edifício Comercial Gaylord, 114-118 Estrada Lockhart, Wan Chai, Hong Kong

