



# MAX5535 Evaluation Kit

## General Description

The MAX5535 evaluation kit (EV kit) provides a proven design to evaluate the MAX5535 dual, 12-bit DACs. The EV kit also includes Windows® 2000/XP-compatible software that provides a simple graphical user interface (GUI) for exercising the features of the MAX5535.

The MAX5535 EV kit PCB comes with a MAX5535ETC+ installed. Contact the factory for free samples of the pin-compatible MAX553\_ETC+, MAX552\_ETC+, or MAX551\_ETC+ devices. The hardware and software support evaluation of these devices as well.

Windows is a registered trademark of Microsoft Corp.

SPI is a trademark of Motorola, Inc.

## Features

- ◆ Wide 1.8V to 5.5V Supply Range
- ◆ USB-PC Connection (Cable Included)
- ◆ USB Powered
- ◆ Lead-Free and RoHS-Compliant
- ◆ 4-Pin Signal Header
- ◆ Accepts Through-Hole Gain-Setting Resistors
- ◆ SPI™ Interface Terminals
- ◆ Optional 2.5V On-Board Reference (MAX6126)
- ◆ Proven PCB Layout
- ◆ Fully Assembled and Tested

## Ordering Information

PART	TYPE	PC INTERFACE
MAX5535EVKIT+	EV Kit	USB

+Denotes lead-free and RoHS-compliant.

## Component List

DESIGNATION	QTY	DESCRIPTION
C1, C3–C10, C17, C21–C25, C28, C30, C31	18	0.1µF ±10%, 16V X7R ceramic capacitors (0603) TDK C1608X7R1C104K
C2, C13, C15, C29, C32	5	10µF ±20%, 6.3V X5R ceramic capacitors (0805) TDK C2012X5R0J106M
C11, C12	2	10pF ±5%, 50V C0G ceramic capacitors (0603) TDK C1608C0G1H100J
C14, C16	2	1µF ±20%, 6.3V X5R ceramic capacitors (0603) TDK C1608X5R0J105K TDK C1608X5R0J105M
C18, C19	2	22pF ±5%, 50V C0G ceramic capacitors (0603) TDK C1608C0G1H220J
C20	1	3300pF ±10%, 50V X7R ceramic capacitor (0603) TDK C1608X7R1H332K
C26	1	2200pF ±10%, 100V C0G ceramic capacitor (0603) Murata GRM188R72A222K
C27	1	4.7µF ±20%, 16V X7R ceramic capacitor (1206) TDK C3216X7R1C475M

DESIGNATION	QTY	DESCRIPTION
D1	1	Green LED (0603) Stanley Electric BG1111C-TR Panasonic LNJ314G8TRA Panasonic LNJ308G84RA
FB1	1	0Ω ±5% resistor (0603) (use lead-free parts only)
H1	1	10-pin dual-row header (2 x 5)
H2	1	4-pin dual-row header (2 x 2)
JUA–JUE	0	Not installed, cut-here PCB trace shorts
JU1–JU5	5	3-pin headers
JU6	1	2-pin header
P1	1	USB type-B right-angle female receptacle Assmann Electronics, Inc. AU-Y1007-R
R1, R8, R10	3	0Ω ±5% resistors (0603) (use lead-free parts only)
R2	1	220Ω ±5% resistor (0603) (use lead-free parts only)
R3	1	10kΩ ±5% resistor (0603) (use lead-free parts only)
R4	1	2.2kΩ ±5% resistor (0603) (use lead-free parts only)
R5	1	1.5kΩ ±5% resistor (0603) (use lead-free parts only)



# MAX5535 Evaluation Kit

## Component List (continued)

DESIGNATION	QTY	DESCRIPTION
R6, R7	2	27Ω ±5% resistors (0603) (use lead-free parts only)
R9, R11	0	Not installed, resistors (0603)
R12–R15	0	Not installed, resistors (through hole)
R16	0	Not installed, resistor (0402) (use lead-free parts only)
U1	1	Dual low-power DAC (12 TQFN-EP*) Maxim MAX5535ETC+
U2	1	Microcontroller (68 QFN-EP*) Maxim MAXQ2000-RAX+
U3	1	93C46 type 3-wire EEPROM (8 SO) 16-bit architecture Atmel AT93C46A-10SU-2.7
U4	1	UART-to-USB converter FTDI FT232BL (32 TQFP)
U5	1	3.3V regulator (5 SC70) Maxim MAX8511EXK33+T (Top Mark: AEI)
U6	1	2.5V regulator (5 SC70) Maxim MAX8511EXK25+T (Top Mark: ADV)

DESIGNATION	QTY	DESCRIPTION
U7	1	Single 1.8V to 5V level translator (6 SOT23) (Top Mark: CT1_) TI SN74LVC1T45DBVT TI SN74LVC1T45DBVR
U8	1	Dual 1.8V to 5V level translators (8 SSOP) (Top Mark: CT2_) TI SN74LVC2T45DCTT TI SN74LVC2T45DCTR
U9	1	2.5V voltage reference (8 SO) Maxim MAX6126AASA25+
Y1	1	16MHz crystal Citizen HCM49-16.000MABJ-UT
Y2	1	6MHz crystal Citizen HCM49-6.000MABJ-UT
—	6	Shunts
—	1	USB high-speed A-to-B cables, 6ft Assmann Electronics AU-Y1002A-R
—	1	PCB: MAX5535 Evaluation Kit+

\*Exposed pad.

## Component Suppliers

SUPPLIER	PHONE	WEBSITE
Murata Electronics North America, Inc.	770-436-1300	www.murata-northamerica.com
TDK Corp.	847-803-6100	www.component.tdk.com

**Note:** Indicate that you are using the MAX5535 when contacting these component suppliers.

## MAX5535 EV Kit Files

FILE	DESCRIPTION
INSTALL.EXE	Installs the EV kit files on your computer
MAX5535.EXE	Application program
HELPIFILE.HTM	MAX5535 EV kit help file
FTD2XX.INF	USB device driver file
UNINST.INI	Uninstalls the EV kit software
TROUBLESHOOTING_USB.PDF	USB driver installation help file

## Quick Start

### Recommended Equipment

Before beginning, the following equipment is needed:

- MAX5535 EV kit (USB cable included)
- A user-supplied Windows 2000/XP PC with a spare USB port
- Two digital voltmeters (DVMs)

**Note:** In the following sections, software-related items are identified by bolding. Text in **bold** refers to items directly from the EV kit software. Text in **bold and underlined** refers to items from the Windows 2000/XP operating system.

### Procedure

The MAX5535 is fully assembled and tested. Follow the steps below to verify board operation:

- 1) Visit [www.maxim-ic.com/evkitsoftware](http://www.maxim-ic.com/evkitsoftware) to download the latest version of the EV kit software, 5535Rxx.ZIP. Save the EV kit software to a temporary folder and uncompress the ZIP file.
- 2) Install the EV kit software on your computer by running the INSTALL.EXE program inside the temporary folder. The program files are copied and icons are created in the Windows **Start | Programs** menu.

# MAX5535 Evaluation Kit

Evaluates: MAX5510/11/14/15/20/21/24/25/30/31/34/35

- 3) Verify that all jumpers (JU1–JU6) are in their default positions, as shown in Table 1.
- 4) To measure OUTA, connect the first DVM between H2-1 (OUTA) and H2-2 (GND).
- 5) To measure OUTB, connect the second DVM between H2-3 (OUTA) and H2-4 (GND).
- 6) Connect the USB cable from the PC to the EV kit board. A **Building Driver Database** window pops up in addition to a **New Hardware Found** message when installing the USB driver for the first time. If you do not see a window that is similar to the one described above after 30s, remove the USB cable from the board and reconnect it. Administrator privileges are required to install the USB device driver on Windows 2000 and XP. Refer to the TROUBLESHOOTING\_USB.PDF document included with the software if any problems arise during this step.
- 7) Follow the directions of the **Add New Hardware Wizard** to install the USB device driver. Choose the **Search for the best driver for your device** option. Specify the location of the device driver to be **C:\Program Files\MAX5535** (default installation directory) using the **Browse** button.
- 8) Start the MAX5535 EV kit software by opening its icon in the **Start | Programs** menu. The EV kit software main window should appear, as shown in Figure 1.
- 9) Enter 0xD2E into the **D11 - D0 (Shift Register Data Bits)** edit box.
- 10) Press the lower **Load DAC A and DAC B** button located at the bottom of the EV kit software main window. This loads input and output DAC registers from the shift register.
- 11) Verify that the voltage shown on both DVMs is approximately 1V.

**Table 1. MAX5535 EV Kit Jumper Descriptions (JU1–JU6)**

JUMPER	SHUNT POSITION	DESCRIPTION
JU1	1-2*	MAX5535 VDD is set to the on-board 3.3V supply powered from the USB port.
	2-3	Connect an external 1.8V to 5V supply to the VDD pad.
JU2	1-2	Connect user-supplied $\overline{CS}$ signal to the on-board $\overline{CS}$ pad.
	2-3*	MAX5535 $\overline{CS}$ signal connected to on-board microcontroller.
JU3	1-2	Connect user-supplied SCLK signal to the on-board SCLK pad.
	2-3*	MAX5535 SCLK signal connected to on-board microcontroller.
JU4	1-2	Connect user-supplied DIN signal to the on-board DIN pad.
	2-3*	MAX5535 DIN signal connected to on-board microcontroller.
JU5	1-2	REFIN = 2.5V from the on-board external reference (MAX6126) for all external reference parts only.
	2-3	REFIN = VDD for external reference parts only.
	Open*	Default state for all internal reference parts with a REFOUT pin. Measure REFOUT at pin 2 of JU5. <b>Note:</b> For external reference parts, connect a 0V to VDD reference voltage to pin 2 of JU5.
JU6	1-2*	Normal operation.
	Open	Measure the MAX5535 supply current by putting a current meter in series with the jumper.

\*Default position.

# MAX5535 Evaluation Kit

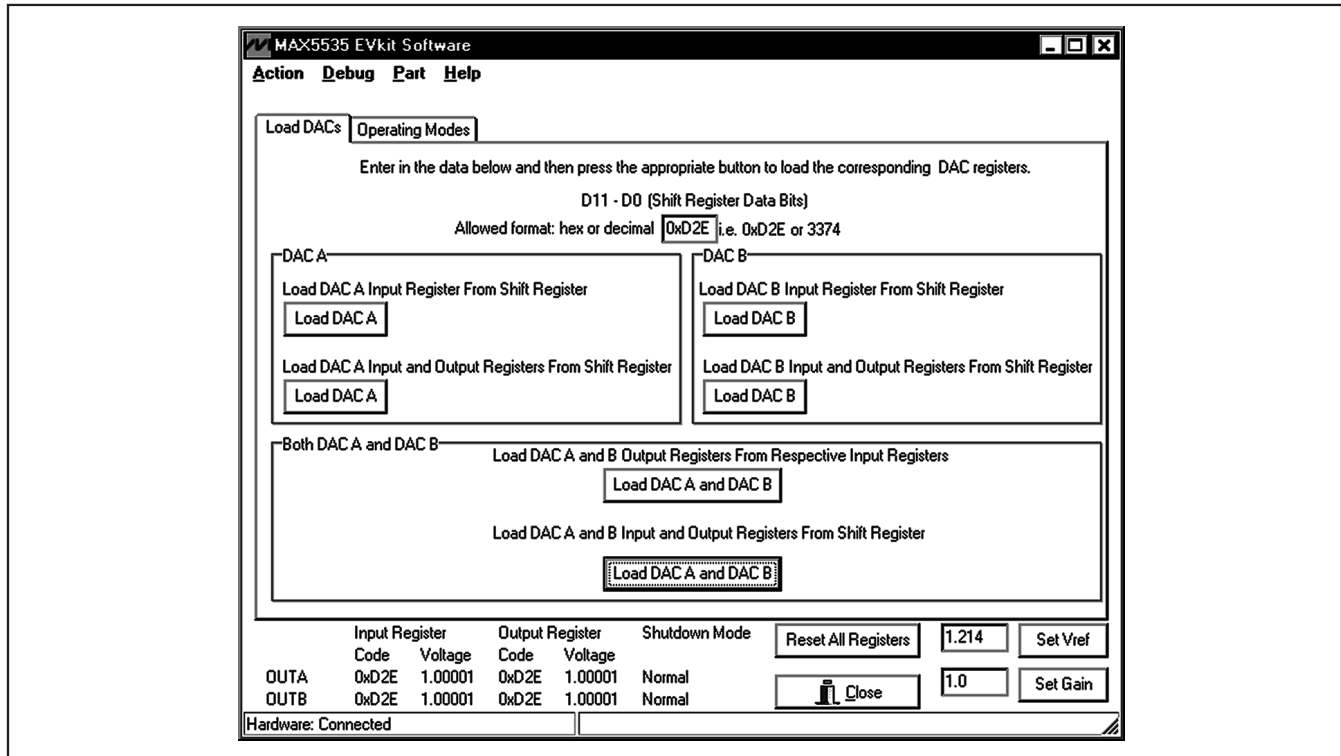

Figure 1. MAX5535 EV Kit Software Main Window (Load DACs Tab)

## Detailed Description of Software

The main window of the evaluation software (shown in Figure 1) displays the voltage and code for all DAC input and output registers. In addition, the main window has two tabs. The **Load DACs** tab sheet controls all the DAC loading features of the MAX5535 family. The **Operating Modes** tab sheet (shown in Figure 2) controls all the DAC modes of the MAX5535 family. The **Load Setting(s)** button must be pressed in order to write the operating mode settings to the DAC(s).

### Part

Select the **Part** menu item at the top of the GUI and check the device that is soldered in the U1 location on the EV kit board. The software selects the MAX5535 as the default device because the EV kit is shipped with a MAX5535ETC+. Contact the factory for free samples of the pin-compatible MAX553\_ETC+, MAX552\_ETC+, or MAX551\_ETC+ devices.

### Debug

Select the **Debug** menu item at the top of the GUI to execute low-level SPI interface commands. Enter data into the **Data bytes to be written** edit box and press the **Send Now** button for manual SPI operations.

## Detailed Description of Hardware

The MAX5535 EV kit provides a proven layout for the MAX5535. An on-board reference, level translators, SPI-interface pads, and easy-to-use USB-PC connection are included on the EV kit.

### Reference

Measure REFOUT at pin 2 of JU5 for all internal reference parts. Enter the value of the internal reference voltage into the **Set Vref** edit box in the software GUI.

For external reference parts, connect a 0V to VDD reference voltage to pin 2 of JU5 or connect the on-board MAX6126 2.5V reference by placing a shunt across pins 1-2 of JU5. Measure and enter the value of the external reference voltage into the **Set Vref** edit box of the software GUI.

### Gain

The default gain is set to 1V/V. To change the gain, first remove R8 and R10. Next, install R8–R11 when using surface-mount resistors, or R12–R15 when using through-hole resistors. Refer to the MAX5535 IC data sheet for information on selecting the resistor values. Enter the new value of the gain into the **Set Gain** field of the software GUI.

# MAX5535 Evaluation Kit

Evaluates: MAX5510/11/14/15/20/21/24/25/30/31/34/35

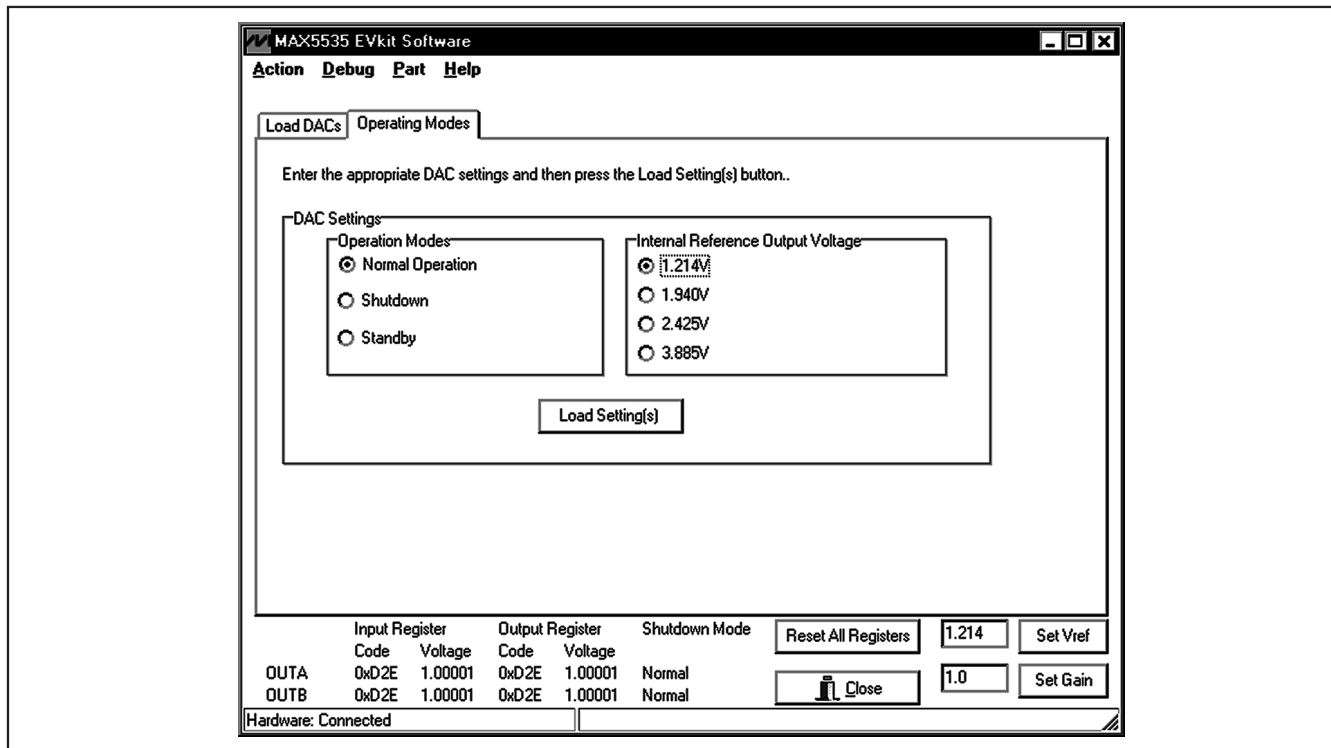

Figure 2. MAX5535 EV Kit Software Main Window (Operating Modes)

## User-Supplied SPI Interface

To use the MAX5535 EV kit with a user-supplied SPI interface, first move the shunts of JU1–JU4 to the 2-3 position. Next apply your own 1.8V to 5.5V power supply at the VDD pad. Lastly, connect your  $\overline{CS}$ , SCLK, and DIN signals to the corresponding  $\overline{CS}$ , SCLK, and DIN pads on the MAX5535 EV kit board.

## User-Supplied Power Supply

The MAX5535 EV kit is powered completely from the USB port as default. Move the shunt of JU1 to the 2-3 position to apply your own 1.8V to 5.5V power supply at the VDD pad.

# MAX5535 Evaluation Kit

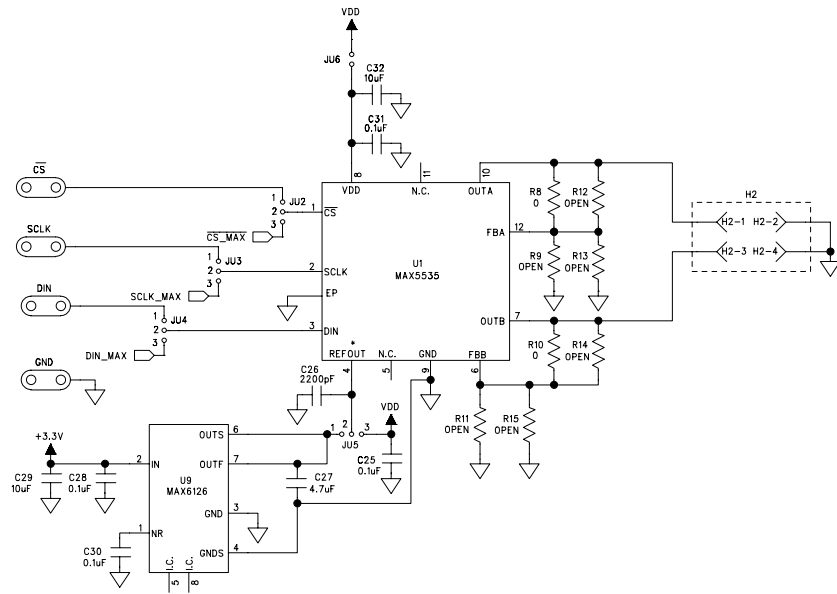

\* REFIN FOR OTHER PARTS IN THE FAMILY

Figure 3a. MAX5535 EV Kit Schematic (Sheet 1 of 2)

# MAX5535 Evaluation Kit

Evaluates: MAX5510/11/14/15/20/21/24/25/30/31/34/35

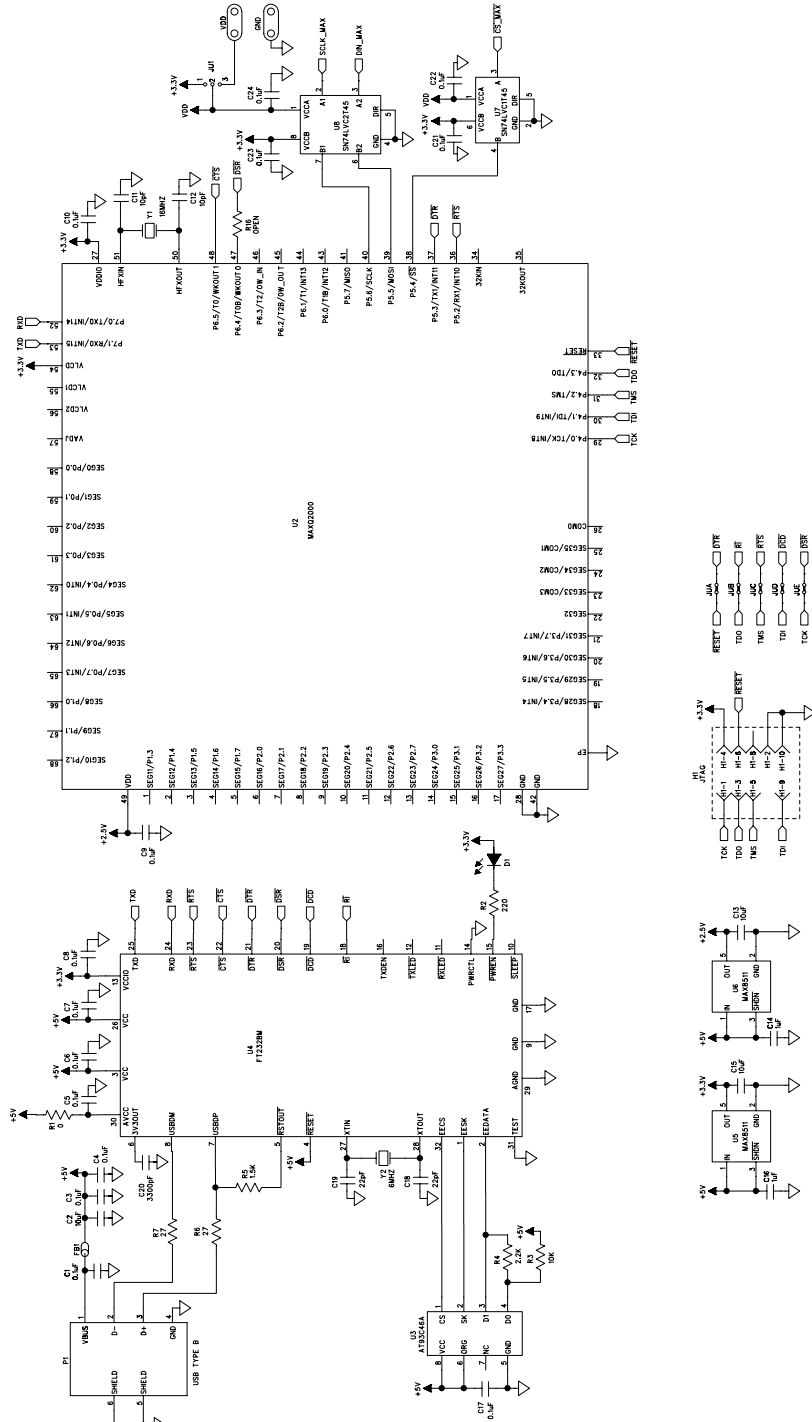

Figure 3b. MAX5535 EV Kit Schematic (Sheet 2 of 2)

# MAX5535 Evaluation Kit

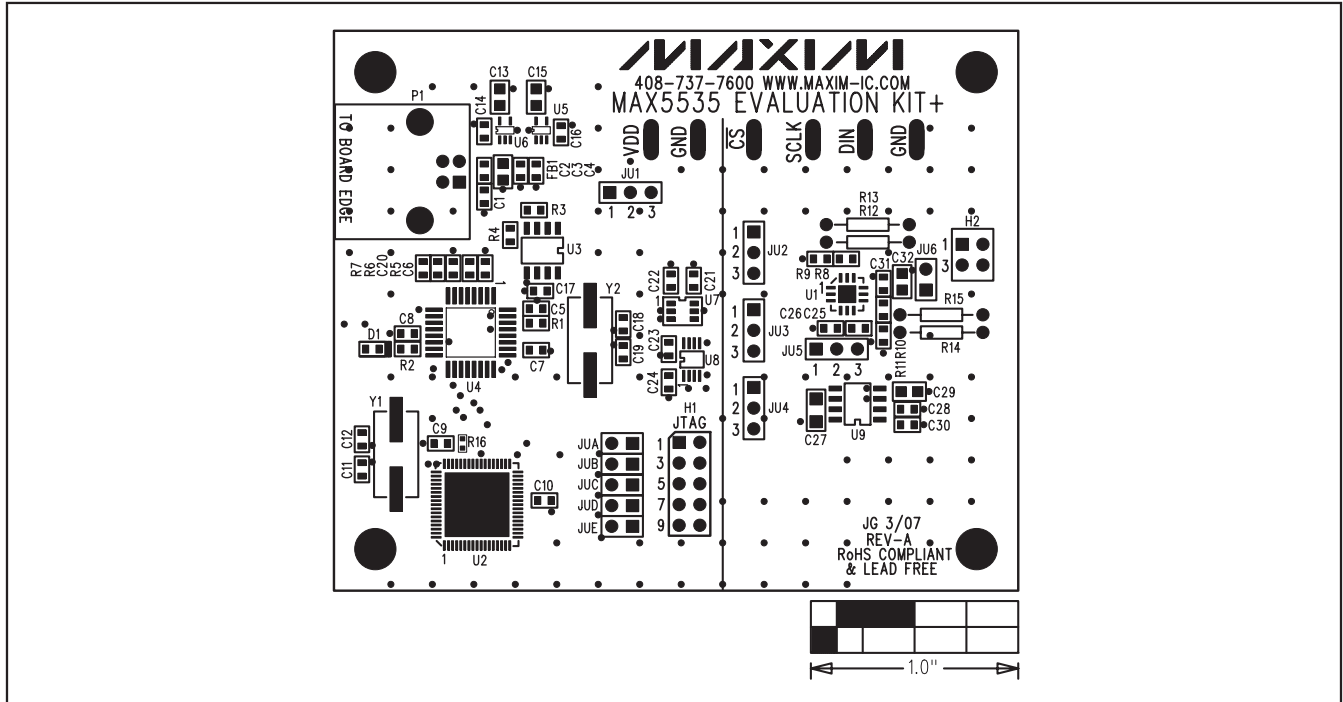

Figure 4. MAX5535 EV Kit Component Placement Guide—Component Side

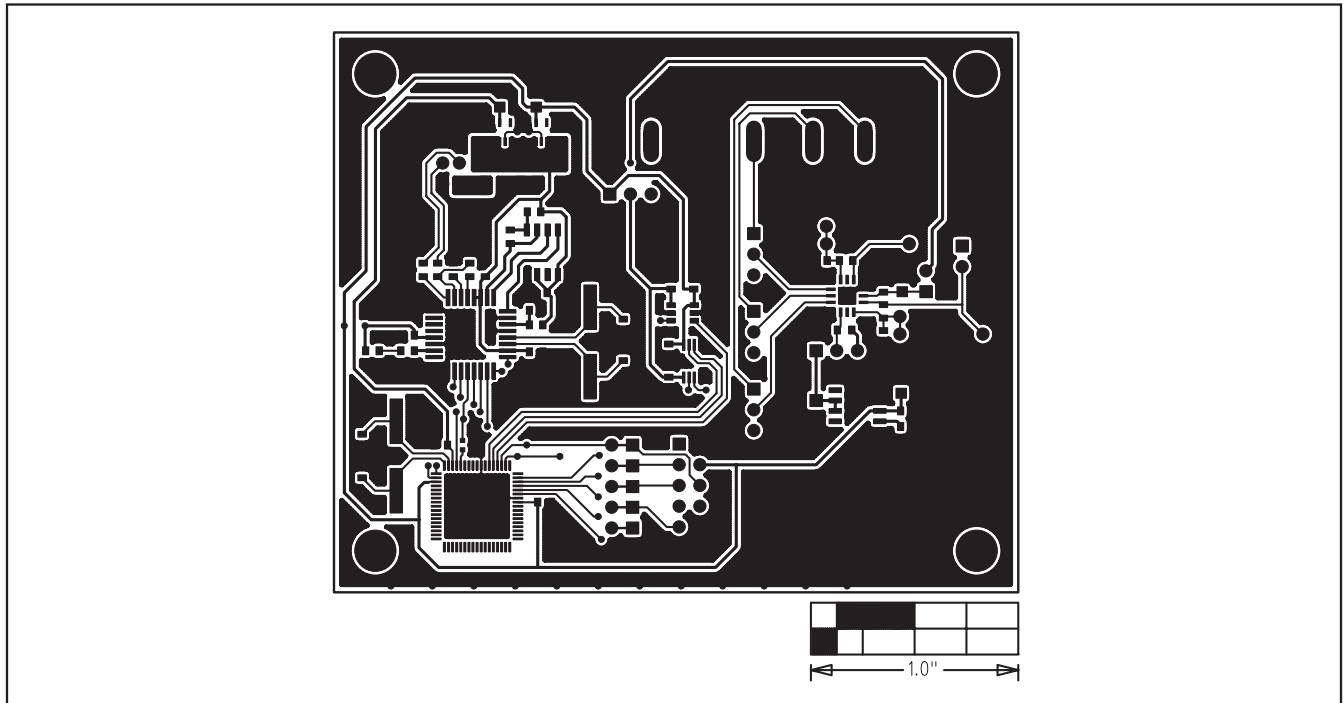

Figure 5. MAX5535 EV Kit PCB Layout—Component Side



# MAX5535 Evaluation Kit

Evaluates: MAX5510/11/14/15/20/21/24/25/30/31/34/35

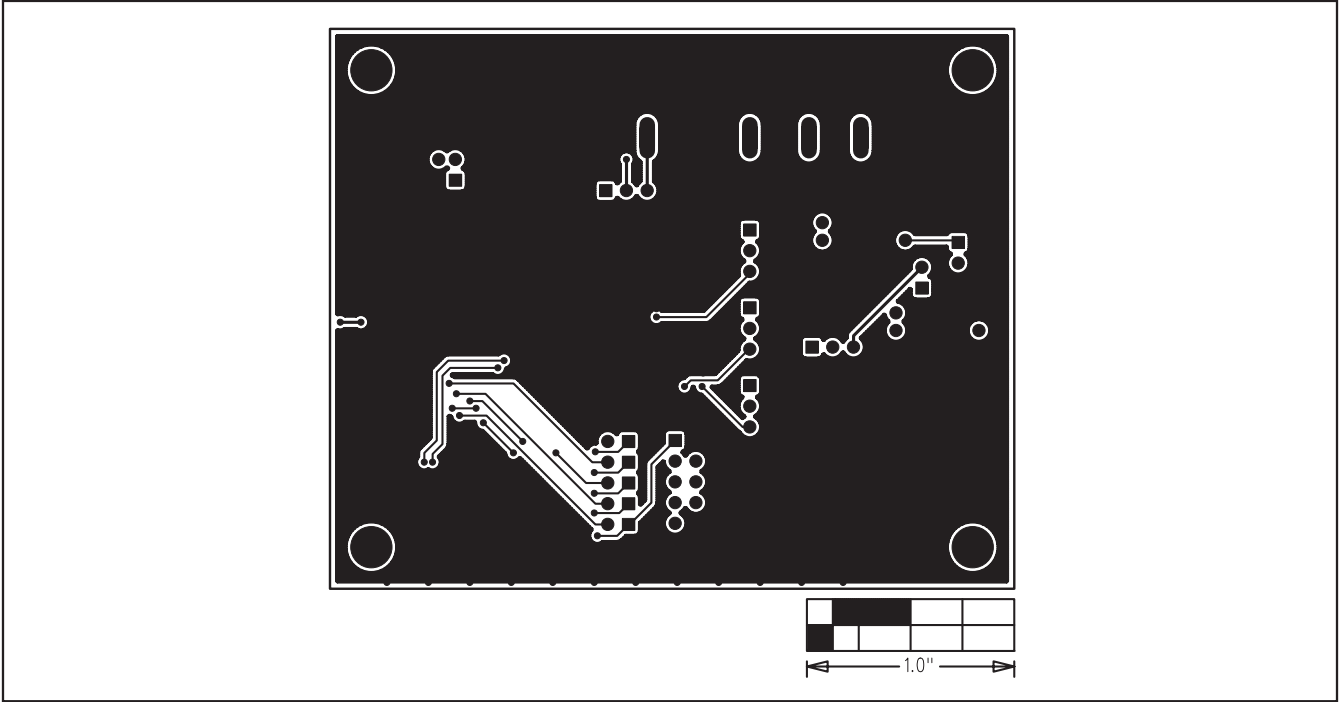

Figure 6. MAX5535 EV Kit PCB Layout—Solder Side

**Evaluates: MAX5510/11/14/15/20/21/24/25/30/31/34/35**

# MAX5535 Evaluation Kit

## Revision History

REVISION NUMBER	REVISION DATE	DESCRIPTION	PAGES CHANGED
0	6/07	Initial release	—
1	4/08	Fixed errors in schematics (Figures 3a and 3b).	6, 7

Maxim cannot assume responsibility for use of any circuitry other than circuitry entirely embodied in a Maxim product. No circuit patent licenses are implied. Maxim reserves the right to change the circuitry and specifications without notice at any time.

10 **Maxim Integrated Products, 120 San Gabriel Drive, Sunnyvale, CA 94086 408-737-7600**

© 2008 Maxim Integrated Products

**MAXIM** is a registered trademark of Maxim Integrated Products, Inc.