

## Power Operational Amplifiers



### FEATURES

- High Power Bandwidth — 350 kHz
- High Slew Rate — 20V/ $\mu$ s
- Fast Settling Time — 600ns
- Low Crossover Distortion — Class A/B
- Low Internal Losses — 1.2V at 2A
- High Output Current —  $\pm$ 5A Peak
- Low Input Bias Current — FET Input
- Isolated Case — 300 VDC



### APPLICATIONS

- Motor, Valve and Actuator Control
- Magnetic Deflection Circuits up to 5A
- Power Transducers up to 350 kHz
- Audio Amplifiers up to 30w RMS

### DESCRIPTION

The PA02 and PA02A are wide-band, high output current operational amplifiers designed to drive resistive, inductive and capacitive loads. Their complementary “collector output” stage can swing close to the supply rails and is protected against inductive kickback. For optimum linearity, the output stage is biased for class A/B operation. The safe operating area (SOA) can be observed for all operating conditions by selection of user programmable, current limiting resistors (down to 10mA). Both amplifiers are internally compensated but are not recommended for use as unity gain followers. For continuous operation under load, mounting on a heat-sink of proper rating is recommended.

These hybrid integrated circuits utilize thick film (cermet) resistors, ceramic capacitors and semiconductor chips to maximize reliability, minimize size and give top performance. Ultrasonically bonded aluminum wires provide reliable interconnections at all operating temperatures. The 8-pin TO-3 package is hermetically sealed and electrically isolated. Isolation washers are not recommended. The use of compressible thermal washers and/or improper mounting torque will void the product warranty. Please see Application Note 1 “General Operating Considerations.”

TYPICAL CONNECTIONS

Figure 1: Typical Connections

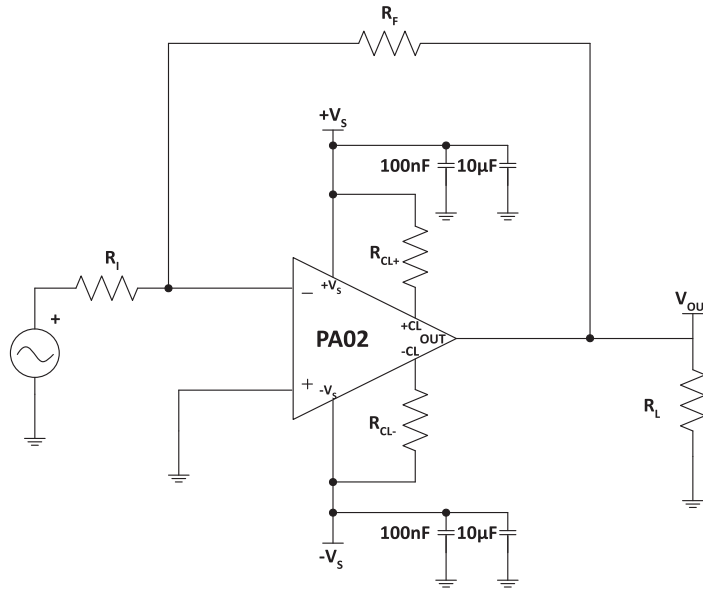

PINOUT AND DESCRIPTION TABLE

Figure 2: External Connections

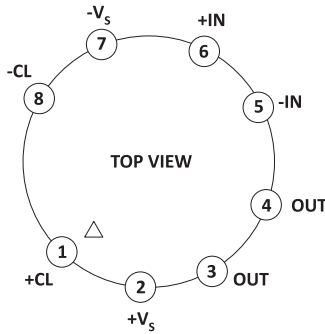

Pin Number	Name	Description
1	+CL	Connect to the sourcing current limit resistor, and then the +Vs pin. Power supply current flows into this pin through $R_{CL+}$ .
2	+Vs	The positive supply rail.
3, 4	OUT	The output. Connect this pin to load and to the feedback resistors. (Pins 3 and 4 are internally connected).
5	-IN	The inverting input.
6	+IN	The non-inverting input.
7	-Vs	The negative supply rail.
8	-CL	Connect to the sinking current limit resistor, and then the -Vs pin. Power supply current flows out of this pin through $R_{CL-}$ .

## SPECIFICATIONS

The power supply voltage for all specifications is the TYP rating unless otherwise noted as a test condition. Full temperature specifications are guaranteed but not 100% tested. The absolute maximum negative input voltage is equal to the negative power supply voltage plus 1V ( $-V_S + 1V$ ).

### ABSOLUTE MAXIMUM RATINGS

Parameter	Symbol	Min	Max	Units
Supply Voltage, total	$+V_S$ to $-V_S$		38	V
Output Current, within SOA	$I_O$		5	A
Power Dissipation, internal <sup>1</sup>	$P_D$		48	W
Input Voltage, differential	$V_{IN (Diff)}$	-30	30	V
Input Voltage, common mode	$V_{cm}$	$-V_S + 2V$	$+V_S - 2V$	V
Temperature, pin solder, 10s max.			350	°C
Temperature, junction <sup>1</sup>	$T_J$		150	°C
Temperature Range, storage		-65	+150	°C
Operating Temperature Range, case	$T_C$	-55	+125	°C

1. Long term operation at the maximum junction temperature will result in reduced product life. Derate internal power dissipation to achieve high MTTF.

### CAUTION

The internal substrate contains beryllia (BeO). Do not break the seal. If accidentally broken, do not crush, machine, or subject to temperatures in excess of 850°C to avoid generating toxic fumes.

**INPUT**

Parameter	Test Conditions	PA02			PA02A			Units
		Min	Typ	Max	Min	Typ	Max	
Offset Voltage, initial	T <sub>C</sub> = 25°C		±5	±10		±1	±3	mV
Offset Voltage vs. temperature	Full temp range		±10	±50		*	±25	µV/°C
Offset Voltage vs. supply	T <sub>C</sub> = 25°C		±10			*		µV/V
Offset Voltage vs. power	T <sub>C</sub> = 25°C		±6			*		µV/W
Bias Current, initial	T <sub>C</sub> = 25°C		50	200		25	100	µA
Bias Current vs. temperature	T <sub>C</sub> = 85°C			200			*	µA/°C
Bias Current vs. supply	T <sub>C</sub> = 25°C		0.01				P	µA/V
Offset Current, initial	T <sub>C</sub> = 25°C		25	100		15	50	µA
Offset Current vs. temperature	T <sub>C</sub> = 85°C			100			*	µA/°C
Input Impedance, DC	T <sub>C</sub> = 25°C		1000			*		GΩ
Input Capacitance	T <sub>C</sub> = 25°C		3			*		pF
Common Mode Voltage Range <sup>1</sup> , Pos.	Full temp range	+V <sub>S</sub> -6	+V <sub>S</sub> -3		*	*		V
Common Mode Voltage Range <sup>1</sup> , Neg.	Full temp range	-V <sub>S</sub> +6	-V <sub>S</sub> +5		*	*		V
Common Mode Rejection, DC	Full temp range	70	100		*	*		dB

1. Exceeding CMV range can cause the output to latch.

**GAIN**

Parameter	Test Conditions	PA02			PA02A			Units
		Min	Typ	Max	Min	Typ	Max	
Open Loop Gain @ 10 Hz	T <sub>C</sub> = 25°C, 1 kΩ load		103			*		dB
Open Loop Gain @ 10 Hz	Full temp range, 10 kΩ load	86	100		*	*		dB
Gain Bandwidth Product @ 1 MHz	T <sub>C</sub> = 25°C, 10 Ω load		4.5			*		MHz
Power Bandwidth	T <sub>C</sub> = 25°C, 10 Ω load		350			*		kHz
Phase Margin	Full temp range, 10 Ω load		30			*		°

**OUTPUT**

Parameter	Test Conditions	PA02			PA02A			Units
		Min	Typ	Max	Min	Typ	Max	
Voltage Swing <sup>1</sup>	T <sub>C</sub> =25°C, I <sub>O</sub> = 5A, R <sub>CL</sub> = 0.08 Ω	±V <sub>S</sub> -4	±V <sub>S</sub> -3		*	*		V
Voltage Swing <sup>1</sup>	Full temp range, I <sub>O</sub> = 2A	±V <sub>S</sub> -2	±V <sub>S</sub> -1.2		*	*		V
Current, peak	T <sub>C</sub> = 25°C	5			*			A
Settling Time to 0.1%	T <sub>C</sub> =25°C, 2V step		0.6			*		μs
Slew Rate	T <sub>C</sub> = 25°C	13	20		*	*		V/μs
Capacitive Load	Full temp range, A <sub>V</sub> > 10		SOA			*		
Harmonic Distortion	P <sub>O</sub> =0.5W, F = 1 kHz, R <sub>L</sub> = 10 Ω		0.004			*		V
Small Signal rise/fall time	R <sub>L</sub> = 10 Ω, A <sub>V</sub> = 1		100			*		ns
Small Signal overshoot	R <sub>L</sub> = 10 Ω, A <sub>V</sub> = 1		10			*		%

1. +V<sub>S</sub> and -V<sub>S</sub> denote the positive and negative supply rail respectively. Total V<sub>S</sub> is measured from +V<sub>S</sub> to -V<sub>S</sub>.

**POWER SUPPLY**

Parameter	Test Conditions	PA02			PA02A			Units
		Min	Typ	Max	Min	Typ	Max	
Voltage	Full temp range	±7	±15	±19	*	*	*	V
Current, Quiescent	T <sub>C</sub> = 25°C		27	40		*	*	mA

**THERMAL**

Parameter	Test Conditions	PA02			PA02A			Units
		Min	Typ	Max	Min	Typ	Max	
Resistance, AC junction to case <sup>1</sup>	F > 60 Hz		1.9	2.1		*	*	°C/W
Resistance, DC junction to case	F < 60 Hz		2.4	2.6		*	*	°C/W
Resistance, junction to air			30			*		°C/W
Temperature Range, case	Meets full range specifications	-25		+85	-55		+125	°C

1. Rating applies if the output current alternates between both output transistors at a rate faster than 60 Hz.

**Note:** \* The specification of PA02A is identical to the specification for PA02 in applicable column to the left.

TYPICAL PERFORMANCE GRAPHS

Figure 3: Power Derating

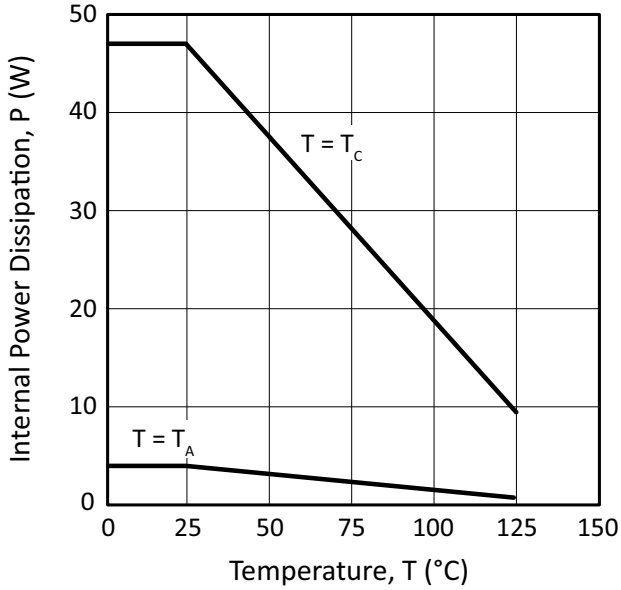

Figure 4: Output Voltage Swing

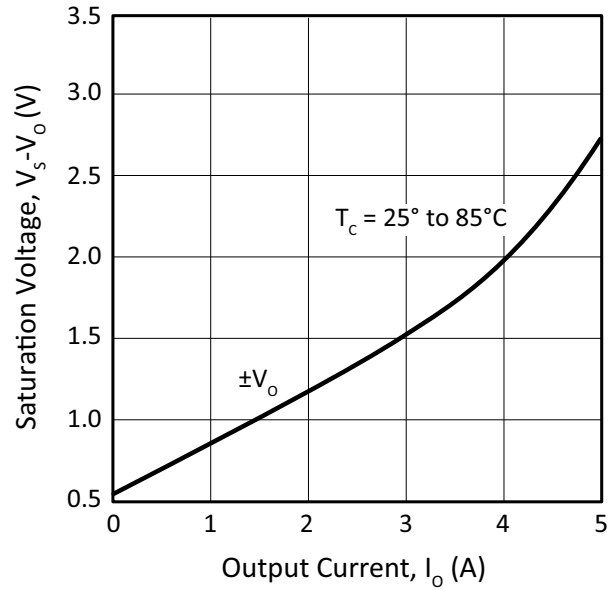

Figure 5: Small Signal Response

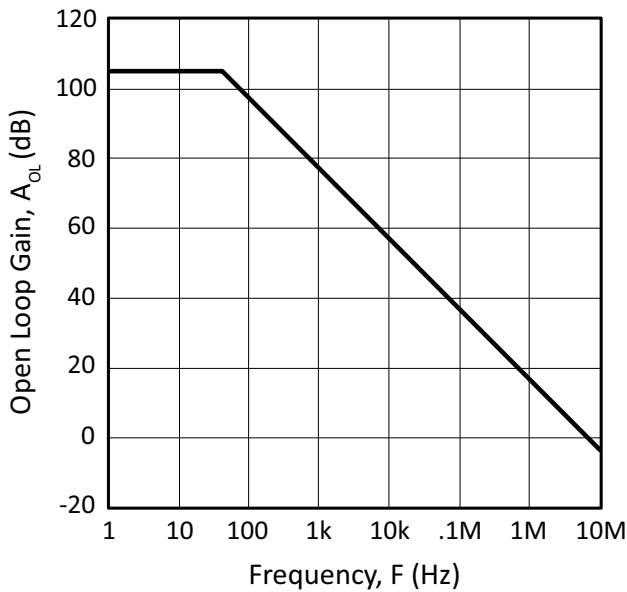

Figure 6: Phase Response

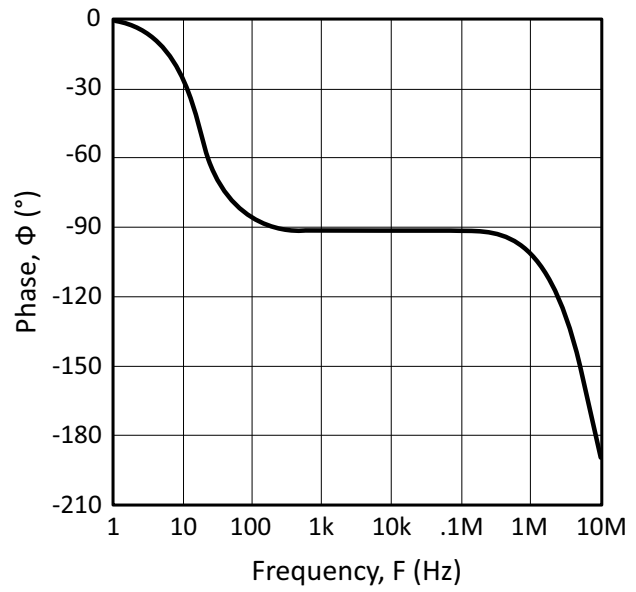

Figure 7: Current Limit

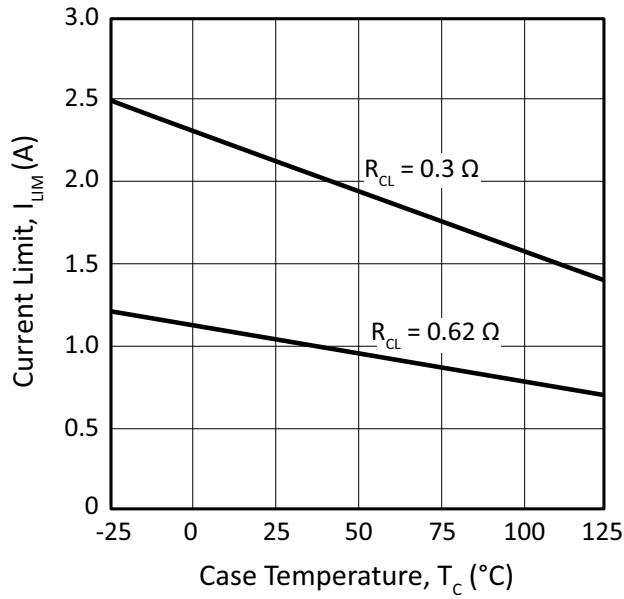

Figure 8: Power Response

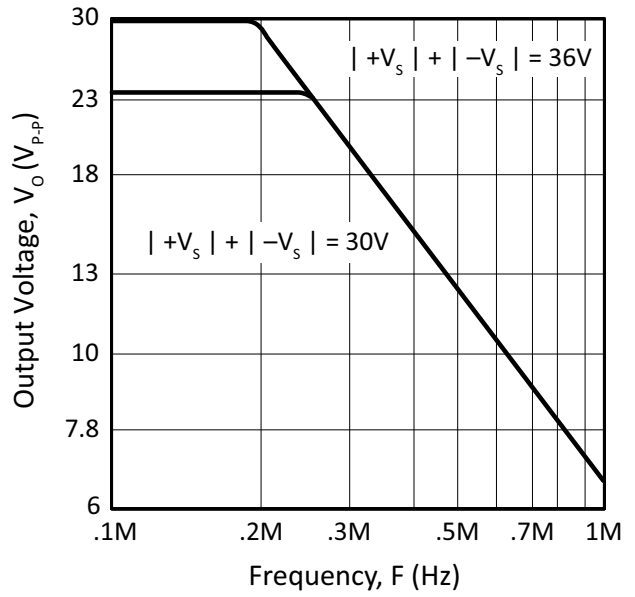

Figure 9: Bias Current

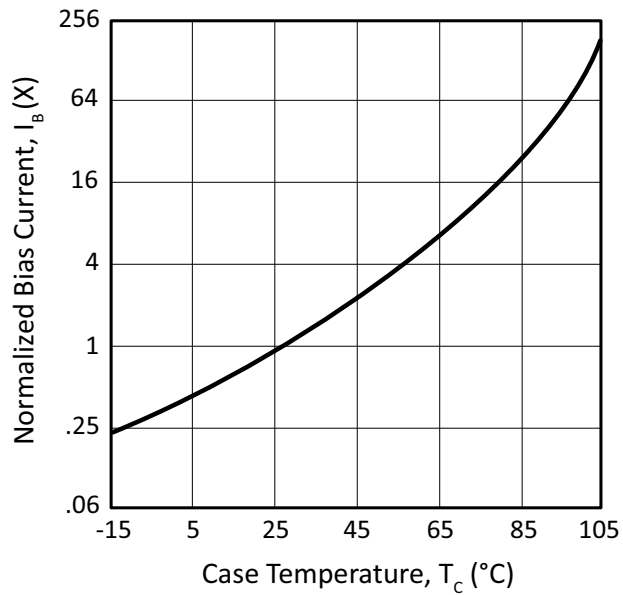

Figure 10: Common Mode Rejection

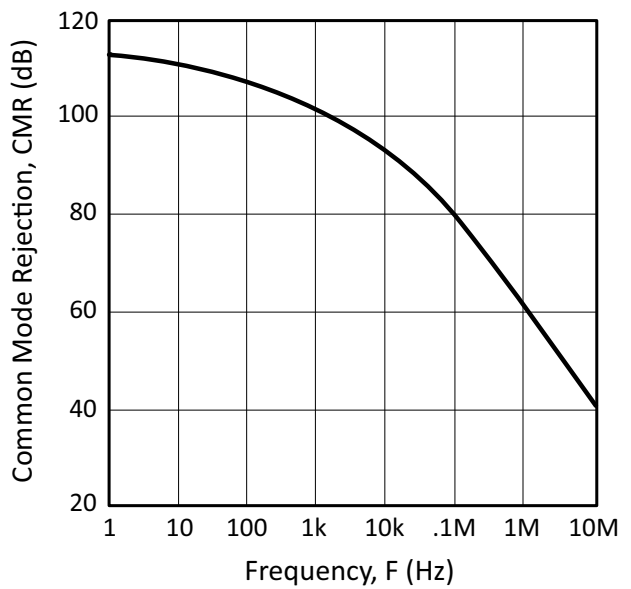

Figure 11: Power Supply Rejection

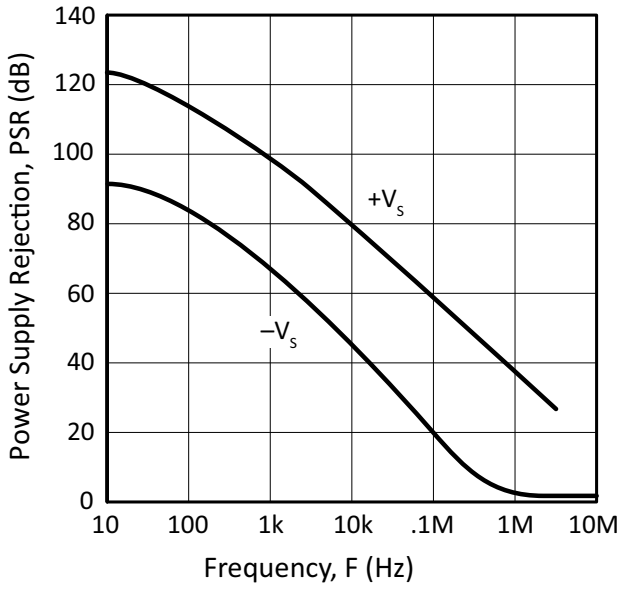

Figure 12: Input Noise

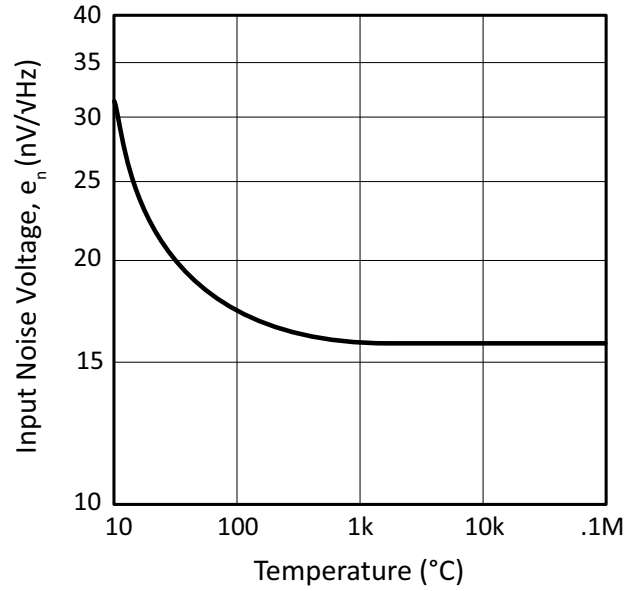

Figure 13: Quiescent Current

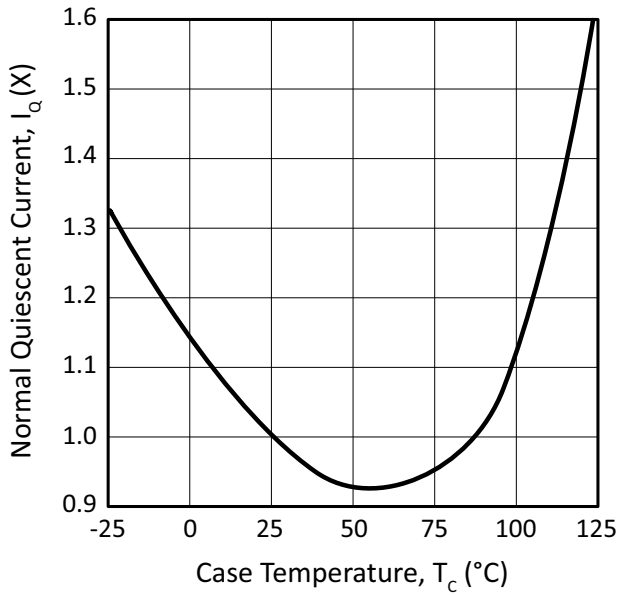

Figure 14: Settling Time

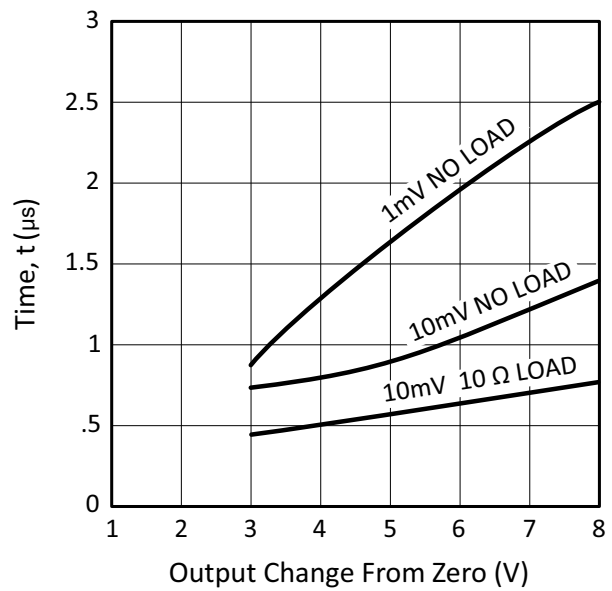



Figure 15: Harmonic Distortion

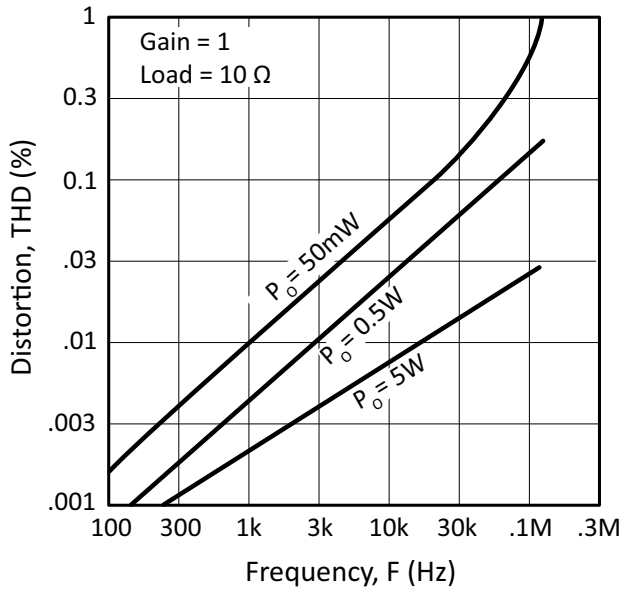

Figure 16: Pulse Response

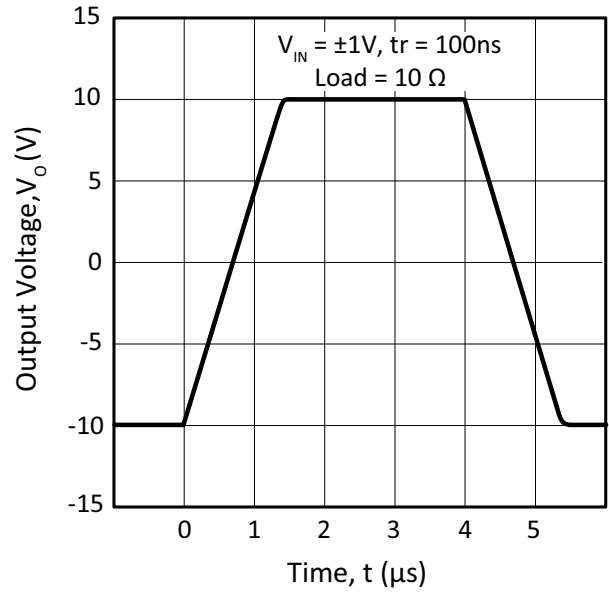

Figure 17: Pulse Response

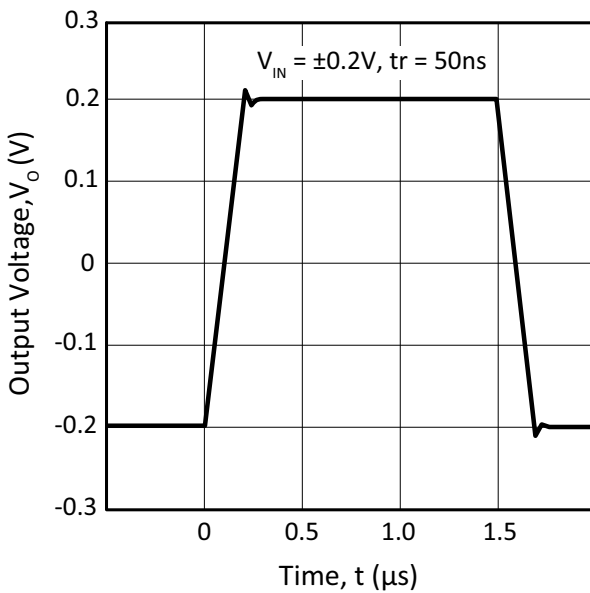
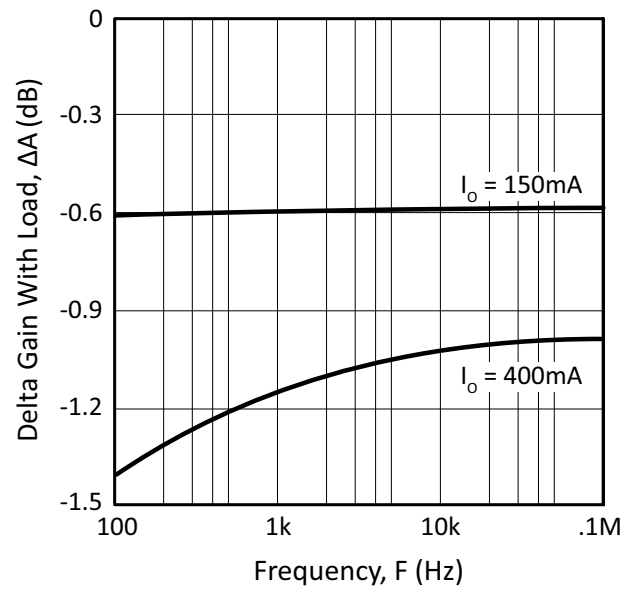

Figure 18: Loading Effects



**SAFE OPERATING AREA (SOA)**

The SOA curves combine the effect of all limits for this Power Op Amp. For a given application, the direction and magnitude of the output current should be calculated or measured and checked against the SOA curves. This is simple for resistive loads but more complex for reactive and EMF generating loads. The following guidelines may save extensive analytical efforts:

- Under transient conditions, capacitive and dynamic\* loads up to the following maximums are safe:

$\pm V_S$	CAPACITIVE LOAD		INDUCTIVE LOAD	
	$I_{LIM} = 2A$	$I_{LIM} = 5A$	$I_{LIM} = 2A$	$I_{LIM} = 5A$
18V	2 mF	0.7 mF	0.2 H	10 mH
15V	10 mF	2.2 mF	0.7 H	25 mH
10V	25 mF	10 mF	5 H	50 mH

\* If the inductive load is driven near steady state conditions, allowing the output voltage to drop more than 8V below the supply rail with  $I_{LIM} = 5A$ , or 17V below the supply rail with  $I_{LIM} = 2A$  while the amplifier is current limiting, the inductor should be capacitively coupled or the current limit must be lowered to meet SOA criteria.

- The amplifier can handle any EMF generating or reactive load and short circuits to the supply rails or shorts to common if the current limits are set as follows at  $T_C = 85^\circ C$ .

$\pm V_S$	Short to $\pm V_S$ C, L, or EMF Load	Short to Common
18V	0.5A	1.7A
15V	0.7A	2.8A
10V	1.6A	4.2A

These simplified limits may be exceeded with further analysis using the operating conditions for a specific application.

**Figure 19: SOA**

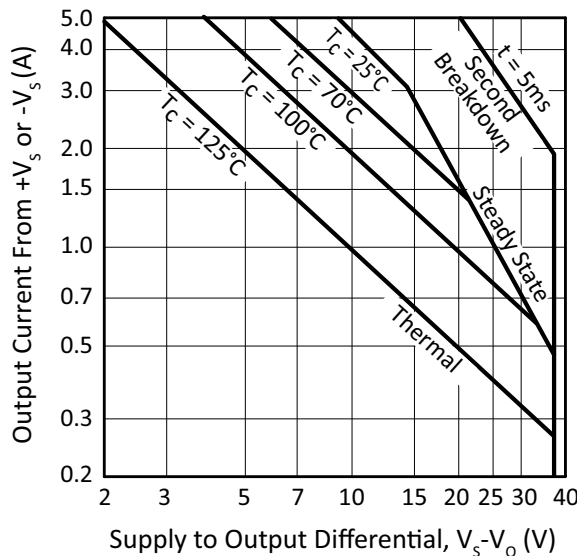

## GENERAL

Please read Application Note 1 “General Operating Considerations” which covers stability, supplies, heat sinking, mounting, current limit, SOA interpretation, and specification interpretation. Visit [www.apexanalog.com](http://www.apexanalog.com) for Apex Microtechnology’s complete Application Notes library, Technical Seminar Workbook, and Evaluation Kits.

## TYPICAL APPLICATION

### LOW INTERNAL LOSS MAXIMIZES EFFICIENCY

When system voltages are low and power is at a premium, the PA02 is a natural choice. The circuit below utilizes not only the feature of low internal loss of the PA02, but also its very low distortion level to implement a crystal clear audio amplifier suitable even for airborne applications. This circuit uses AC coupling of both the input signal and the gain circuit to render DC voltage across the speaker insignificant. The resistor and capacitor across the inputs form a stability enhancement network. The 0.27 ohm current limit resistors provide protection in the event of an output short circuit.

Figure 20: Typical Application (Vehicular Sound System Power Stage)

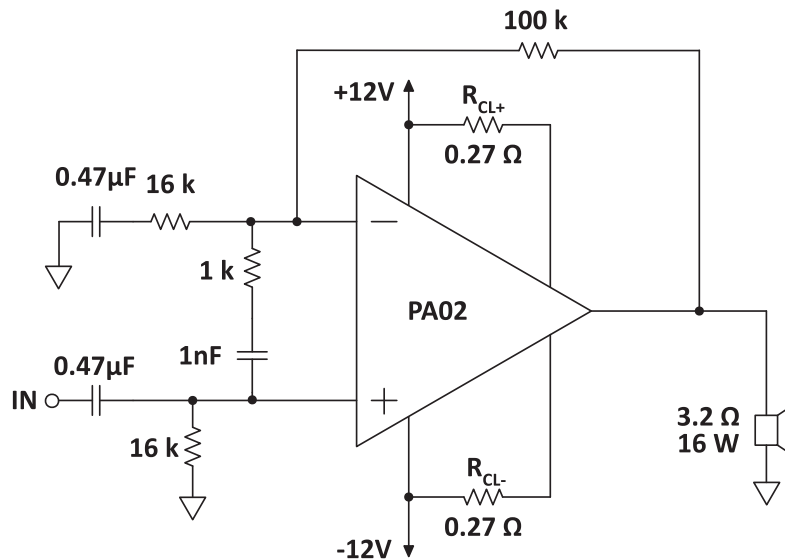

## CURRENT LIMIT

Proper operation requires the use of two current limit resistors, connected as shown in the external connection diagram. The minimum value for  $R_{CL}$  is 0.12 ohm, however for optimum reliability it should be set as high as possible.

$$R_{CL}(\Omega) = \frac{0.65V}{I_{LIM}(A)}$$

Where:

$I_{LIM}$  is the current limit in amperes

$R_{CL}$  is the current limit resistor value in ohms

Refer to Application Note 1 “General Operating Considerations” section of the handbook for current limit adjust details.

## DEVICE MOUNTING

The case (mounting flange) is electrically isolated and should be mounted directly to a heatsink with thermal compound. Screws with Belville spring washers are recommended to maintain positive clamping pressure on heatsink mounting surfaces. Long periods of thermal cycling can loosen mounting screws and increase thermal resistance.

Since the case is electrically isolated (floating) with respect to the internal circuits it is recommended to connect it to common or other convenient AC ground potential.

**PACKAGE OPTIONS**

**PACKAGE STYLE CE**

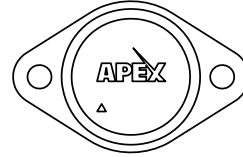
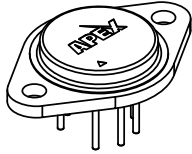

**Ordinate dimensions for CAD layout**

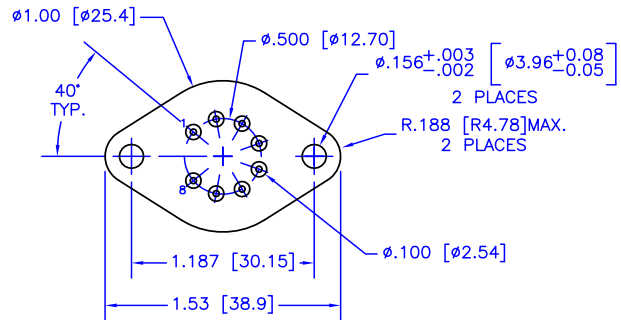
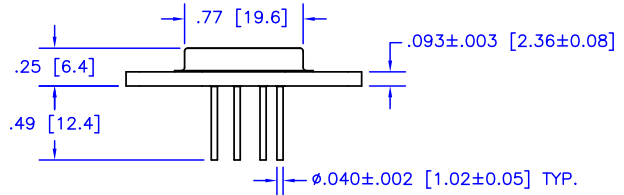
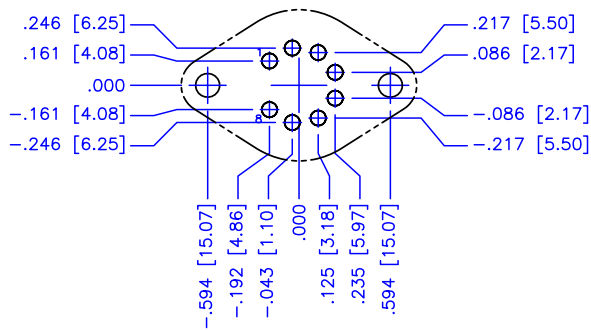

**NOTES:**

1. Dimensions are inches & [mm].
2. Triangle printed on lid denotes pin 1.
3. Header flatness within pin circle is .0005" TIR, max.
4. Header flatness between mounting holes is .0015" TIR, max.
5. Standard pin material: Solderable nickel-plated Alloy 52.
6. Header material: Nickel-plated cold-rolled steel.
7. Welded hermetic package seal
8. Isolation: 500 VDC any pin to case.
9. Package weight: .53 oz [15 g]

---

## NEED TECHNICAL HELP? CONTACT APEX SUPPORT!

For all Apex Microtechnology product questions and inquiries, call toll free 800-546-2739 in North America. For inquiries via email, please contact [apex.support@apexanalog.com](mailto:apex.support@apexanalog.com). International customers can also request support by contacting their local Apex Microtechnology Sales Representative. To find the one nearest to you, go to [www.apexanalog.com](http://www.apexanalog.com)

---

### IMPORTANT NOTICE

Apex Microtechnology, Inc. has made every effort to insure the accuracy of the content contained in this document. However, the information is subject to change without notice and is provided "AS IS" without warranty of any kind (expressed or implied). Apex Microtechnology reserves the right to make changes without further notice to any specifications or products mentioned herein to improve reliability. This document is the property of Apex Microtechnology and by furnishing this information, Apex Microtechnology grants no license, expressed or implied under any patents, mask work rights, copyrights, trademarks, trade secrets or other intellectual property rights. Apex Microtechnology owns the copyrights associated with the information contained herein and gives consent for copies to be made of the information only for use within your organization with respect to Apex Microtechnology integrated circuits or other products of Apex Microtechnology. This consent does not extend to other copying such as copying for general distribution, advertising or promotional purposes, or for creating any work for resale.

APEX MICROTECHNOLOGY PRODUCTS ARE NOT DESIGNED, AUTHORIZED OR WARRANTED TO BE SUITABLE FOR USE IN PRODUCTS USED FOR LIFE SUPPORT, AUTOMOTIVE SAFETY, SECURITY DEVICES, OR OTHER CRITICAL APPLICATIONS. PRODUCTS IN SUCH APPLICATIONS ARE UNDERSTOOD TO BE FULLY AT THE CUSTOMER OR THE CUSTOMER'S RISK.

Apex Microtechnology, Apex and Apex Precision Power are trademarks of Apex Microtechnology, Inc. All other corporate names noted herein may be trademarks of their respective holders.