





Grayhill, Inc.

62S11-N5-120S

Número da peça:	62S11-N5-120S
Fabricante / Marca:	Grayhill, Inc.
Descrição do Produto	ROTARY ENCODER OPTICAL 32PPR
Folhas de dados:	 62S11-N5-120S.pdf
Status de RoHS	 Sem chumbo / RoHS complacente
Condição de estoque	1675 pcs stock
Navio De	Hong Kong
Caminho de embarque	DHL/Fedex/TNT/UPS/EMS



[SOLICITAÇÃO DE COTAÇÃO](#)

Imagem pode ser representação. Veja as especificações para detalhes do produto.

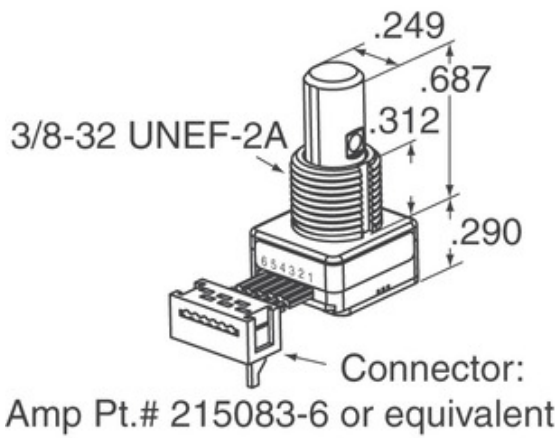

Especificações do 62S11-N5-120S

NÚMERO DA PEÇA	62S11-N5-120S
FABRICANTE	Grayhill, Inc.
DESCRIÇÃO	ROTARY ENCODER OPTICAL 32PPR
STATUS SEM CHUMBO / STATUS ROHS	Sem chumbo / RoHS complacente
QUANTIDADE DISPONÍVEL	1675 pcs
FICHA DE DADOS	 62S11-N5-120S.pdf
TENSÃO - FORNECIMENTO	5V
ESTILO DE ACABAMENTO	Cable Leads
SÉRIE	62S
VIDA DE ROTAÇÃO (CICLOS MIN)	1M
PULSOS POR REVOLUÇÃO	32
TIPO DE SAÍDA	Quadrature (Incremental)
OUTROS NOMES	62S11N5120S
ORIENTAÇÃO	Vertical
TIPO DE MONTAGEM	Panel Mount
NÍVEL DE SENSIBILIDADE À UMIDADE (MSL)	1 (Unlimited)
STATUS SEM CHUMBO / STATUS DE ROHS	Lead free / RoHS Compliant
TIPO ENCODER	Optical
DETENTOR	No
CONSTRUÍDO EM MUDAR	Yes
TIPO DE ATUADOR	1/4" Dia Flatted End

Tags relacionadas

Grayhill, Inc. 62S11-N5-120S	Distribuidor 62S11-N5-120S	Fornecedor 62S11-N5-120S
Preço 62S11-N5-120S	Fotos de 62S11-N5-120S	Imagem 62S11-N5-120S
Folha de dados em PDF 62S11-N5-120S	Folha de dados do download de 62S11-N5-120S	Folha de dados 62S11-N5-120S
Estoque 62S11-N5-120S	Compre 62S11-N5-120S	Compre Grayhill, Inc. 62S11-N5-120S
Grayhill, Inc. 62S11-N5-120S	Fornecedor Grayhill, Inc.	Distribuidor Grayhill, Inc.
Grayhill, Inc. 62S11-N5-120S	Grayhill Inc. 62S11-N5-120S	

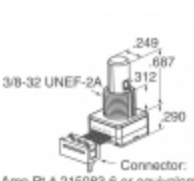
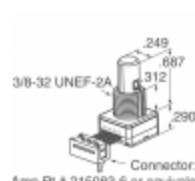
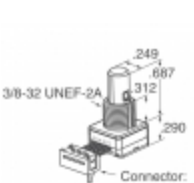
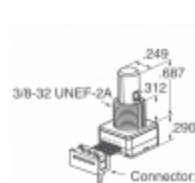
produtos relacionados

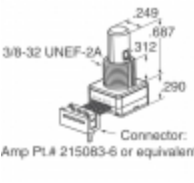
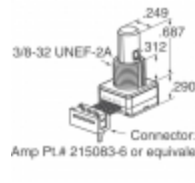
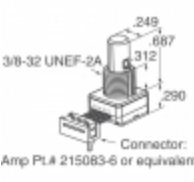
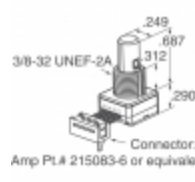
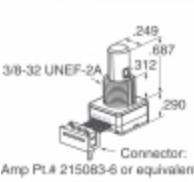
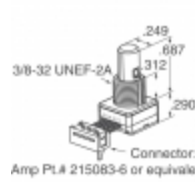
 <p>62S11-N9-060C Fabricantes: Grayhill, Inc. Descrição: ROTARY ENCODER OPTICAL 32PPR Em estoque: 2192 pcs</p> <p>RFQ</p>	 <p>62S11-N5-040C Fabricantes: Grayhill, Inc. Descrição: ROTARY ENCODER OPTICAL 32PPR Em estoque: 2106 pcs</p> <p>RFQ</p>
 <p>62S11-N9-PH Fabricantes: Grayhill, Inc. Descrição: ROTARY ENCODER OPTICAL 32PPR Em estoque: 2219 pcs</p> <p>RFQ</p>	 <p>62S11-N5-060SH Fabricantes: Grayhill, Inc. Descrição: ROTARY ENCODER OPTICAL 32PPR Em estoque: 2263 pcs</p> <p>RFQ</p>
 <p>62S11-N5-PV Fabricantes: Grayhill, Inc. Descrição: ROTARY ENCODER OPTICAL 32PPR Em estoque: 2220 pcs</p> <p>RFQ</p>	 <p>62S11-N5-P Fabricantes: Grayhill, Inc. Descrição: ROTARY ENCODER OPTICAL 32PPR Em estoque: 1885 pcs</p> <p>RFQ</p>
 <p>62S11-N5-050C Fabricantes: Grayhill, Inc. Descrição: ROTARY ENCODER OPTICAL 32PPR Em estoque: 1936 pcs</p> <p>RFQ</p>	 <p>62S11-N5-080SH Fabricantes: Grayhill, Inc. Descrição: ROTARY ENCODER OPTICAL 32PPR Em estoque: 1942 pcs</p> <p>RFQ</p>
 <p>62S11-N5-100C Fabricantes: Grayhill, Inc. Descrição: ROTARY ENCODER OPTICAL 32PPR Em estoque: 1789 pcs</p> <p>RFQ</p>	 <p>62S11-N5-060C Fabricantes: Grayhill, Inc. Descrição: ROTARY ENCODER OPTICAL 32PPR Em estoque: 2164 pcs</p> <p>RFQ</p>
 <p>62S11-N9-060SH Fabricantes: Grayhill, Inc. Descrição: ROTARY ENCODER OPTICAL 32PPR Em estoque: 1801 pcs</p> <p>RFQ</p>	 <p>62S11-N9-120S Fabricantes: Grayhill, Inc. Descrição: ROTARY ENCODER OPTICAL 32PPR Em estoque: 1784 pcs</p> <p>RFQ</p>

Copyright © 2020 Distribuidor confiável de componentes eletrônicos

O email: Info@infinity-electronic.com

Endereço: 17F, Edifício Comercial Gaylord, 114-118 Estrada Lockhart, Wan Chai, Hong Kong

